

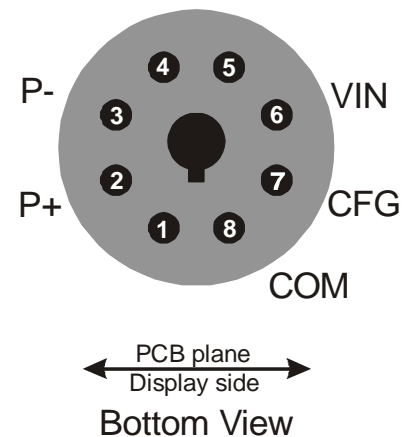

Digital "Panel" Meter

- Convenient octal glass tube package
- 3-1/2 digit measurement
- 2V full-scale input
- Power supply isolated from input up to 1500V
- Programmable units display (mA, mV, V, A, blank)
- Applications:
 - B+ voltage measurement
 - Plate or cathode current measurement
 - General metering

Functional Block Diagram

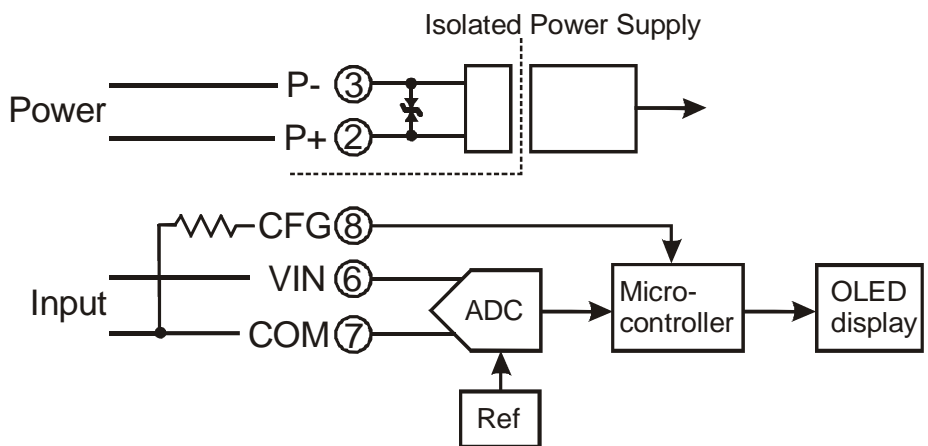

Absolute Maximum Ratings

SYMBOL	PARAMETER	MIN	MAX	UNIT
V_{IN}	Measurement input voltage		±5	V
V_P	Power input voltage		15	VAC
			20	VDC

Pin Connections

PIN	NAME	FUNCTION
1		No connection
2	P+	AC or + DC power input
3	P-	AC or - DC power input
4		No connection
5		No connection
6	VIN	Measurement input
7	CFG	Configuration pin
8	VCOM	Measurement common

Electrical Characteristics

SYMBOL	PARAMETER	CONDITIONS/COMMENTS	MIN	TYP	MAX	UNIT
V _{IN(FS)}	Full-scale input voltage			2.046		V
ΔV _{IN}	Error	<i>Total error is sum of both errors</i>	-1 -2		+1 +2	% counts
V _{ZERO}	Zero reading	V _{IN} connected to V _{COM}	0	0	2	counts
R _{ADS(ON)}	Isolation voltage	Pins 5,7,8 to 2,3			1500	V
V _P	Power input voltage		3.3 4.5		15 20	VAC VDC
I _P	Power input current	V _P = 5 VDC		20	30	mA
I _{IN}	Measurement input current				1	μA
Z _{IN}	Measurement input impedance		10Ωk in series w/ 5pF			
f _{UPD}	Update frequency			500		mS

Dimensions: Standard intermediate octal base - 33.5mm diameter.
Seated height 75mm, bulb diameter 29mm.

Description and Application

The SiTubes DPM is a digital voltmeter, mounted in a glass octal tube envelope. It has a 3-1/2-digit OLED display that can be seen through the glass. It has a fixed input voltage range of 0-2V, and can be easily interfaced with resistor dividers or shunts to measure DC voltage or current.

Unlike most digital meters, the SiTubes DPM integrates a truly isolated power supply, so the measurement ground can float as much as 1500VDC above or below the power source. This allows isolated current measurements, or the use of power sources that have AC or DC biases present. The power source can be AC or DC, and only about 20mA of current is required.

A programmable units indicator may be displayed after the digits. The display is configured by connecting an external resistor between pins 7 and 8. The required resistor for a given display is shown in the table below:

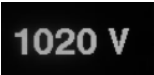
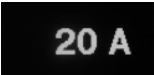
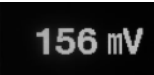
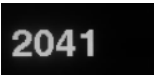
Units	Appearance	Resistor Value
mA		short
V		1.5kΩ
A		2.7kΩ
mV		3.9kΩ
(none)		open

Note that the configuration resistor is only read at power-up.

Customized displays are possible. Minimum quantity and/or engineering charges may apply. Contact SiTubes for more information.

The meter reads out directly in millivolts, from 0 to 2046 for an input from 0V to 2046 millivolts (2.046V) DC.

You can use a voltage divider to measure voltages higher than 2V. To scale for a 0-2000V reading, for example, you need to divide by 1000. Using a 1M Ω series resistor and a 1k Ω resistor to ground will give a factor of 999:1, an error of 0.1%. If measuring high voltage, take care that the resistor used for the divider can withstand the required voltage!

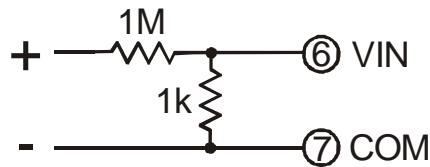

To measure current directly in mA, simply insert a 1 Ω resistor in series with the current you want to measure, and connect the more positive side of the resistor to pin 6, and the other end to pin 8.

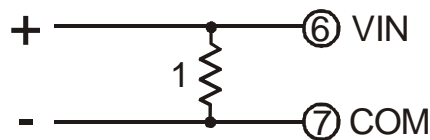

To measure amps, use a 0.001 Ω (one milliohm) shunt. A 4-wire Kelvin connection is essential for high current measurements with such a low-ohm shunt.

The response time of the DPM is already fairly slow - it updates twice per second, and many ADC conversions are averaged for each reading. However, the update can be slowed, or smoothed, by adding a simple RC filter to the input. The input impedance of the ADC is very high, so added series resistance does not significantly hurt the accuracy.

